

FNAME: HLA-4X-4

REVDATE: 0817

REVISIONS				
ZONE	REV	DESCRIPTION	DATE	APPROVED
	A	VARIOUS UPDATES	8/28/17	

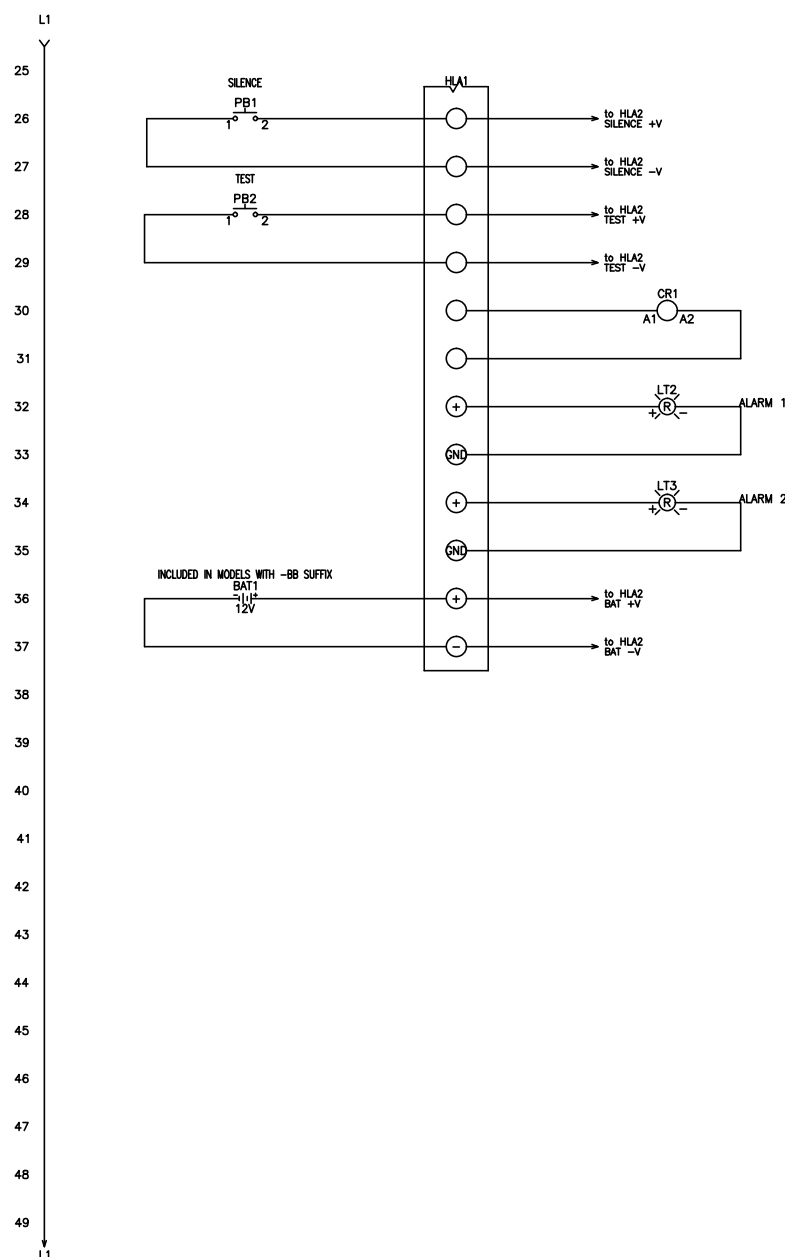
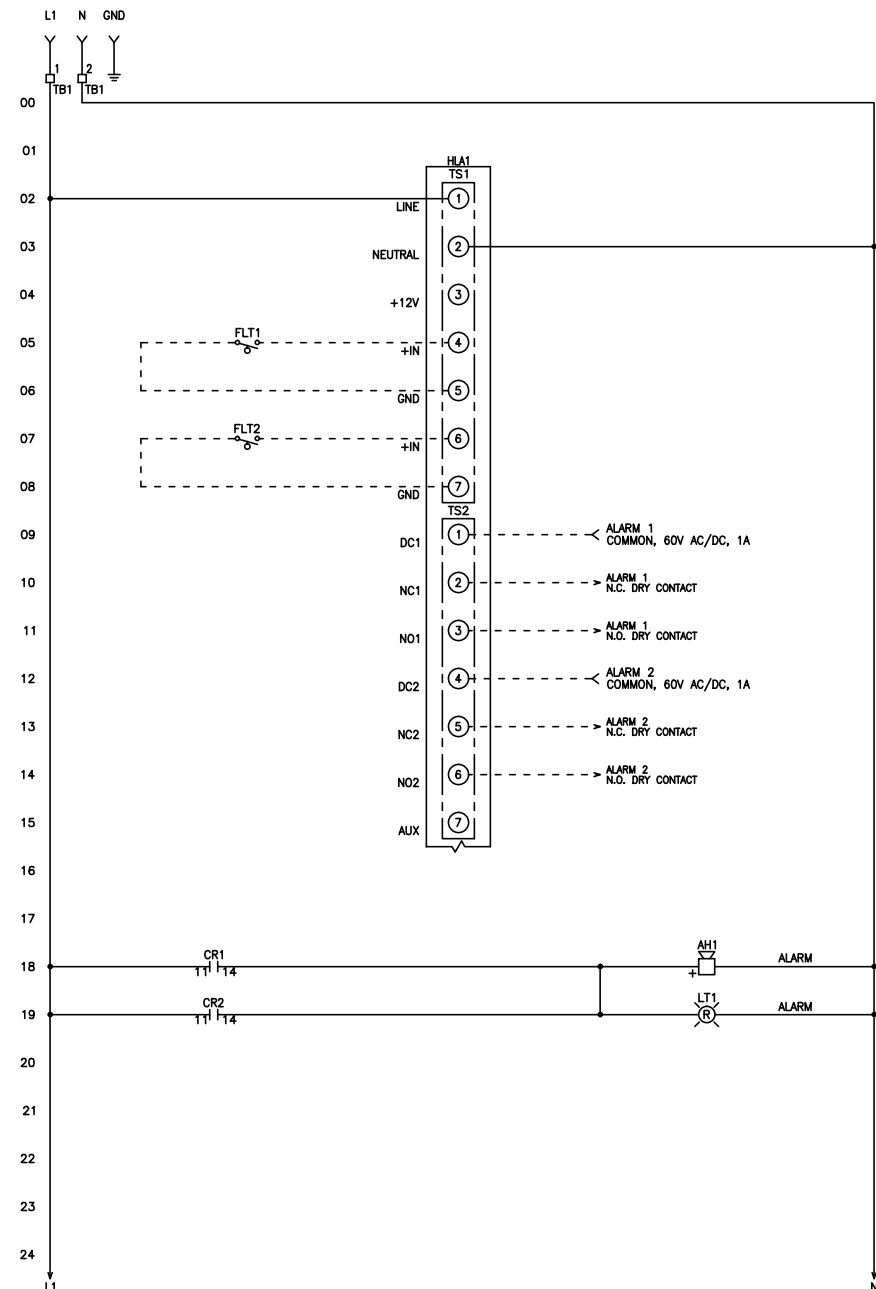

NOTES:
 -S4 SUFFIX INDICATES ALL FLOATS ARE NORMALLY CLOSED FLOATS.
 -32 SUFFIX INDICATES CUSTOM LABELING THAT MAY DIFFER FROM THE STANDARD LABELING AND/OR NORMALLY OPEN AND NORMALLY CLOSED MAY DIFFER FROM DRAWING ABOVE.

----- DASHED LINE INDICATES FIELD WIRING.

USE COPPER CONDUCTORS ONLY.
 TEMPERATURE RATING OF CONDUCTORS IS TO BE 60°C (167°F).
 BRANCH CIRCUIT PROTECTION SHALL BE PROVIDED BY THE INSTALLER; MUST BE SIZED ACCORDING TO PUMP/MOTOR MANUFACTURING SPECIFICATIONS.
 VERIFY CORRECT OPERATION OF CONTROL PANEL AFTER INSTALLATION IS COMPLETE.

DRAWN BY: MM	DATE: 4/30/16				
APPROVED BY:	DATE:				
THIS DRAWING CONTAINS PROPRIETARY INFORMATION AND SHALL NOT BE USED OR DISCLOSED WITHOUT PRIOR WRITTEN AUTHORIZATION.		TITLE: HLA-4X-4 CONTROL SCHEMATIC			
		SIZE B	DWG NO. 1585	PART NO. HLA-4X-4	REV A
		SCALE NONE		SHEET 1 OF 2	

FRAME: HLA-4X-4

REVDATE: 0817

REVISIONS				
ZONE	REV	DESCRIPTION	DATE	APPROVED
	A	VARIOUS UPDATES	8/28/17	

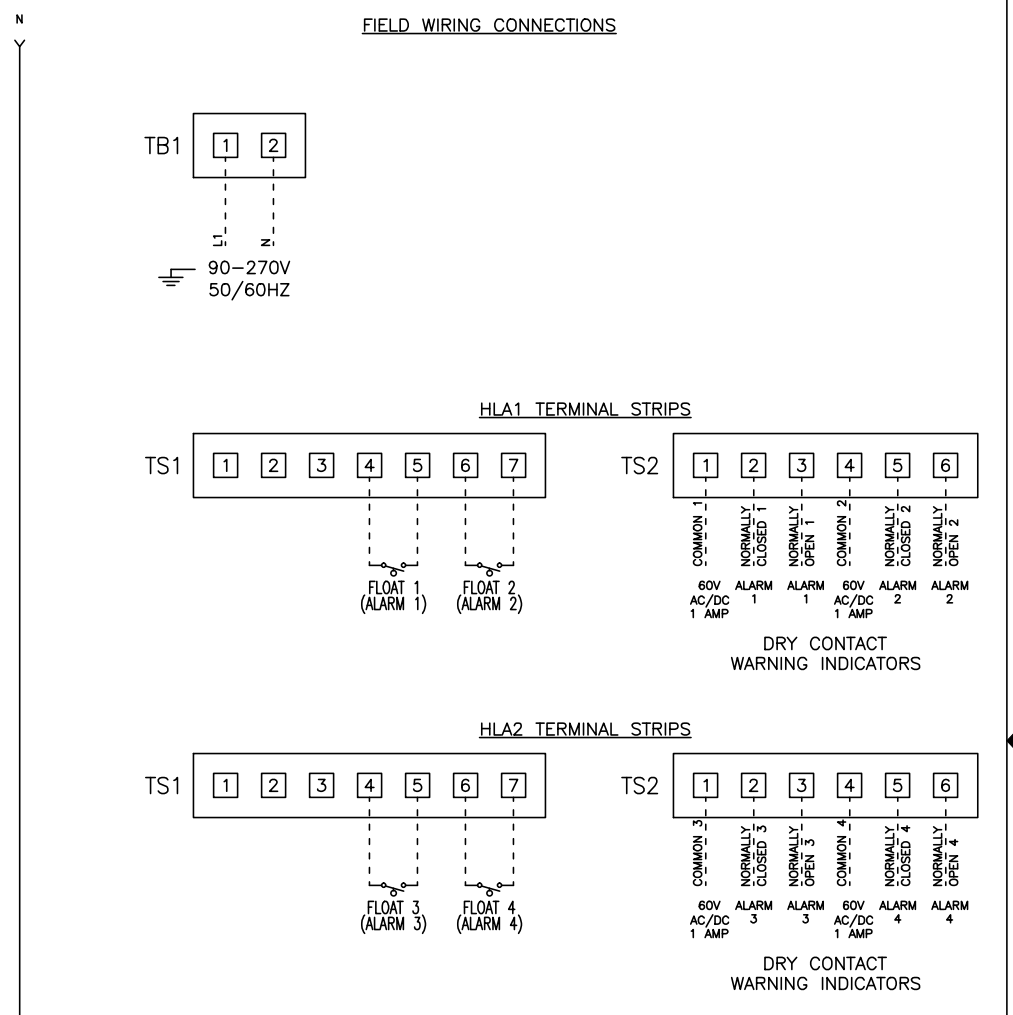
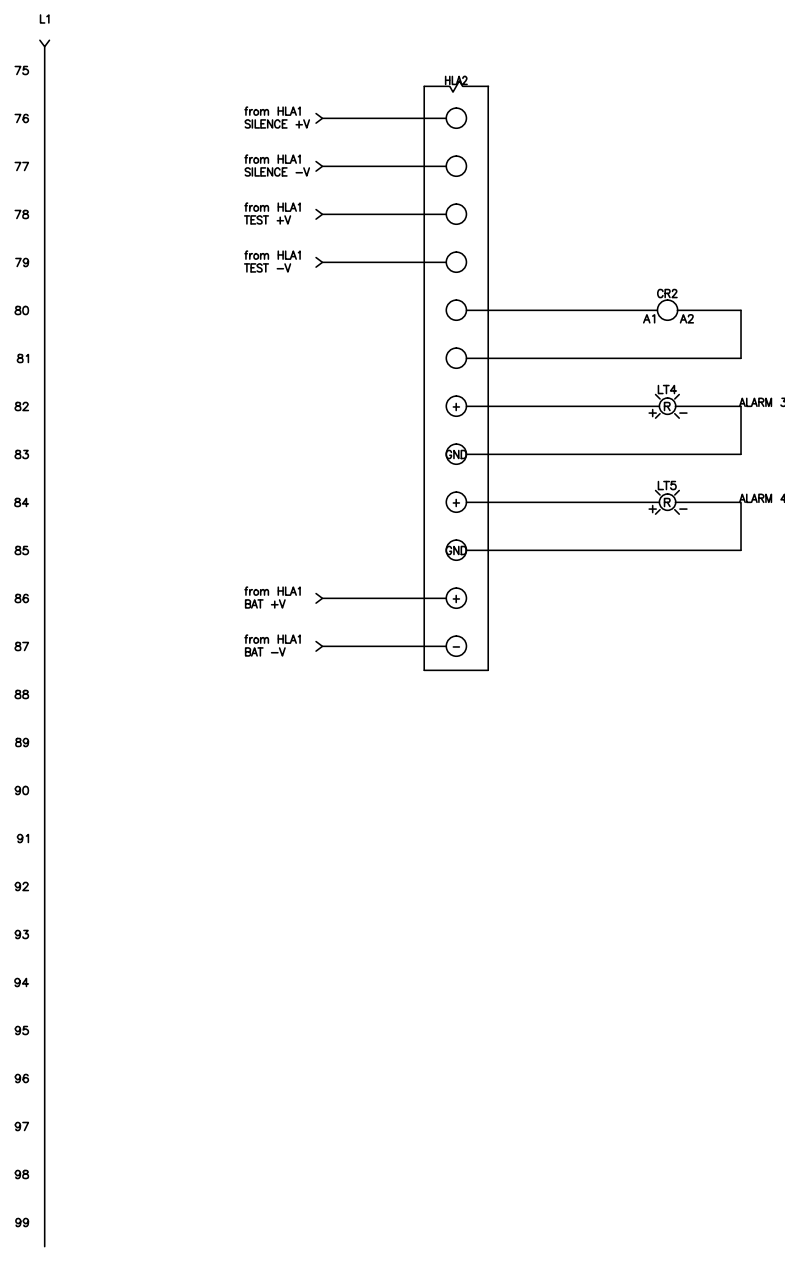
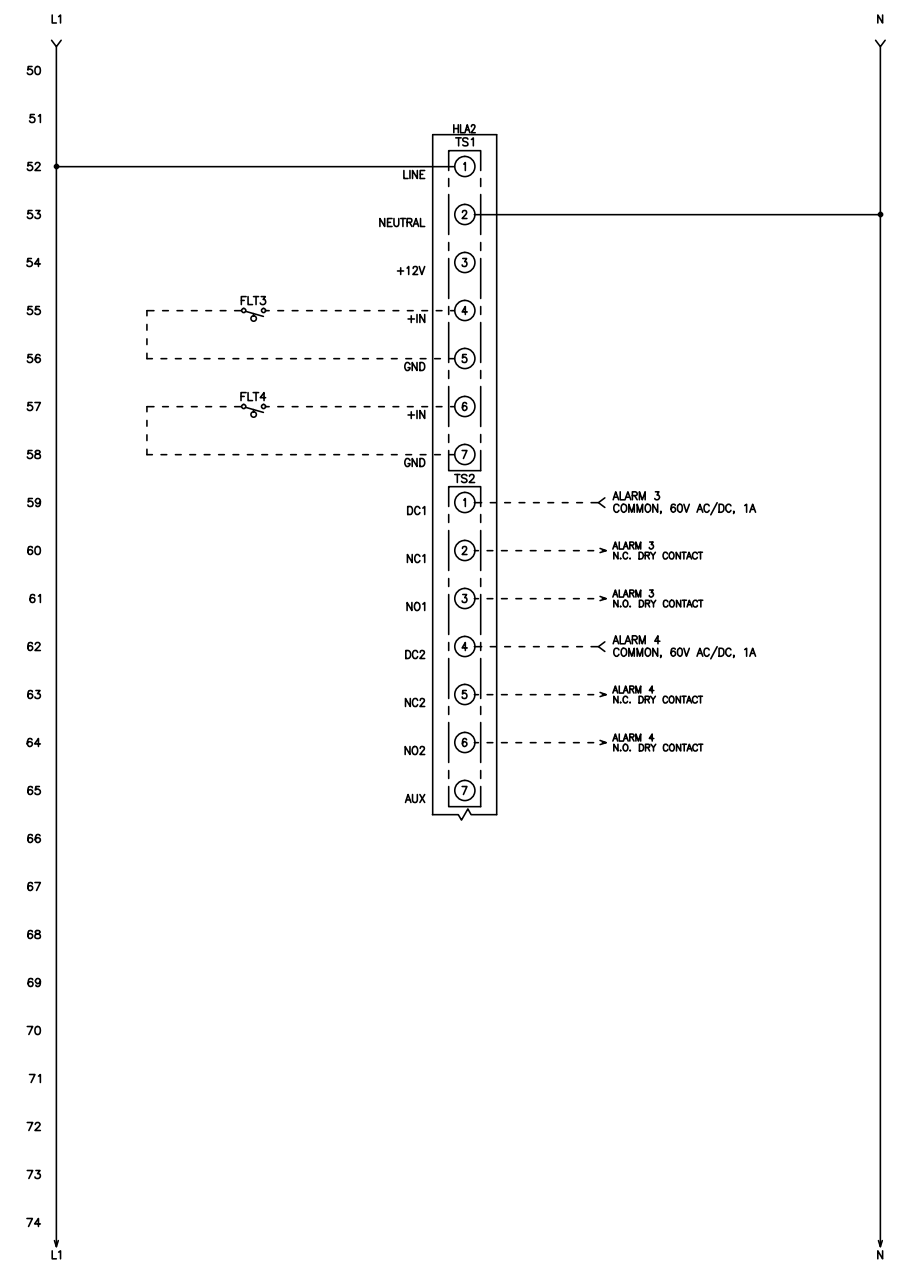

NOTES:
 -S4 SUFFIX INDICATES ALL FLOATS ARE NORMALLY CLOSED FLOATS.
 -32 SUFFIX INDICATES CUSTOM LABELING THAT MAY DIFFER FROM THE STANDARD LABELING AND/OR NORMALLY OPEN AND NORMALLY CLOSED MAY DIFFER FROM DRAWING ABOVE.

----- DASHED LINE INDICATES FIELD WIRING.

USE COPPER CONDUCTORS ONLY.
 TEMPERATURE RATING OF CONDUCTORS IS TO BE 60°C (167°F).
 BRANCH CIRCUIT PROTECTION SHALL BE PROVIDED BY THE INSTALLER; MUST BE SIZED ACCORDING TO PUMP/MOTOR MANUFACTURING SPECIFICATIONS.
 VERIFY CORRECT OPERATION OF CONTROL PANEL AFTER INSTALLATION IS COMPLETE.

DRAWN BY: MM	DATE: 4/30/16				
APPROVED BY:	DATE:				
THIS DRAWING CONTAINS PROPRIETARY INFORMATION AND SHALL NOT BE USED OR DISCLOSED WITHOUT PRIOR WRITTEN AUTHORIZATION.		TITLE: HLA-4X-4 CONTROL SCHEMATIC			
		SIZE B	DWG NO. 1585	PART NO. HLA-4X-4	REV A
		SCALE NONE	SHEET 2 OF 2		