

Oil Smart® Duplex Panel (OSD3P-10)

BN	IM712
REV	1011

Oil Smart® System:

The Oil Smart® System includes the Oil Smart® Water Pump Control, High Water Two Pump Demand Switch, and the Oil Smart® High Liquid Alarm. The Oil Smart® Pump Controller, when combined with a manual pump, automatically pumps water from elevators, transformer containment barriers, underground vaults, substations, and other applications without the risk of pumping oil. While the Oil Smart® Alarm provides information to building management or maintenance personnel about leak or high liquid level conditions at any given location. The alarm will activate with the presence of any liquid and will identify if oil or water is present. Since 1995, the Original and Patented Oil Smart® System has been the reliable choice for safely pumping water. Installation of the Oil Smart® System allows you to comply with State and Federal regulations while reducing the risk of adverse publicity, fines and expensive cleanup costs.

Features:

- No Moving Parts. Patented Electronic Oil Smart®, High Water, and Liquid Smart® Controls
- Indoor/Outdoor NEMA 4X Heavy Duty Polycarbonate Enclosure: , UL-50 Type 6P Listing 16"x14"x7" (Main Disconnect)
- Voltage: 480VAC Three Phase 50/60Hz, 30 Amp Motor Start Relays
- CSA International Certified No. 229594
- External Mounting Feet: Quick Installation.
- High Liquid Alarm with Test and Silence Features, Red Beacon Alarm Light, White Light for Water Present, Yellow Light for Oil Present, High 84 Decibel Audible Alarm. Complete Dry Contacts for Each Alarm Condition.
- Oil Smart Pump Switch, High Water 2 Pump Switch and Liquid Smart Alarm Sensor with 20' cords and mounting brackets.
- HOA Switches and Green Lights for Pump Run
- Includes Pump Disconnect Circuit Breakers
- Total Pump Protection: No Load Lockout Protection, Pump Fault Signals and auxiliary contacts including Red Light pump lockout.
- Main Disconnect for 480V Protection

www.seewaterinc.com
or www.oilsmart.org

951.487.8073 • 888.733.9283

Email: info@seewaterinc.com

121 North Dillon Street • San Jacinto, CA 92583

P.O. Box 1269 • San Jacinto, CA 92581

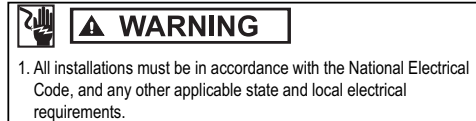

Panel Installation:

- Caution: To maintain the NEMA 4X rating, make all wiring connections with seal tight cable grips or conduit connections to be supplied by end user.
 - I. Determine hole location on panel for liquid-tight or conduit connectors. Drill proper sized holes for conduit connections
 - II. Determine mounting location for control panel. Mount panel using mounting feet supplied
 - III. Attach connectors and conduits.
 - IV. Run pump cable, Liquid Smart® cable, High Water 2 Pump cable, and Oil Smart® cable through conduit. Make field connections as shown on wiring diagram (See Page 3)
 - V. Run power line conductor through conduit. Wire to terminals per enclosed schematic.

Components Installation:

- I. The Oil Smart® Pump Switch, High Water 2 Pump Demand Switch, and Liquid Smart® Alarm Sensor shall be mounted in a clean environment, clear of mud and all metallic debris.
- II. The switches shall be installed where the water intrusion will not directly contact or splash the white plastic case.
- III. Mud or other conductive materials left on the body of the switches will hamper its operation; clean the switch with rubbing alcohol prior to initial installation.
- IV. Mount with enclosed mounting brackets. Note: Keep sensors at least 2" clear of any metallic material.

Oil Smart® Duplex Panel (Model #OSD5P-32)

Testing:

- Liquid Smart® Alarm Sensor: Fill small cup supplied with oil. Submerge only the plastic lens (optic sensor) into oil, the alarm will activate showing oil present (yellow light). Now touch finger to the exposed stainless steel sensor, the alarm will show water present (white light) will turn on.

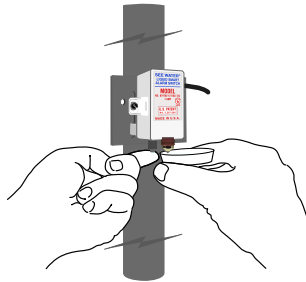

- Oil Smart® Switch: Place the HOA switch on control panel in the automatic position. Place your thumb on the short sensor of Oil Smart® Pump Switch and the pump will turn on. While touching the short sensor, touch the long sensor "off" with your fingers. Remove your thumb from on sensor and begin to move your fingers down the off sensor. Remove your fingers from off sensor and the pump will turn off.

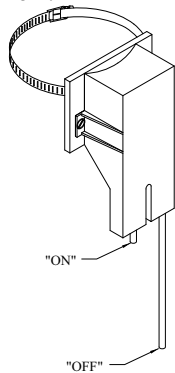

- High Water 2 Pump Demand Switch: While touching "on" sensor of Oil Smart® Switch, touch finger to the sensor of High Water 2 Pump Demand Switch, both pumps will turn on. Repeat process of moving fingers down "off" sensor of Oil Smart® Switch.

Oil Smart® and Liquid Smart Maintenance:

The Oil Smart® Switch is designed for sump environments and tested to withstand the normal environment of a pump switch. The Liquid Smart® Alarm Switch is designed to be used as a High Liquid or Lead Detection alarm switch.

For 24 hour troubleshooting, call 888-733-9283.

Operation:

When water comes in contact with the short (on) sensor, the pump will turn on. The pump will remain on until water clear the long (off) sensor. If oil comes in contact with the on sensor, the pump will not turn on; however the pump switch will activate and pump water from under the oil. Oil does not harm the system in anyway. The sensors can oscillate through oil and see water.

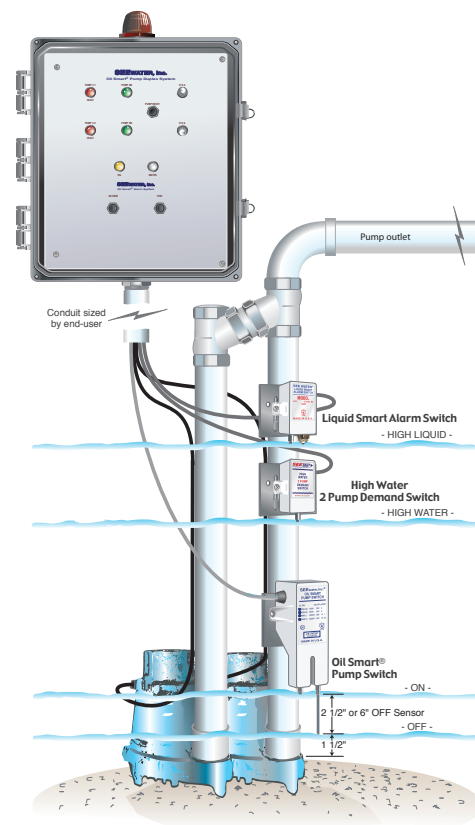
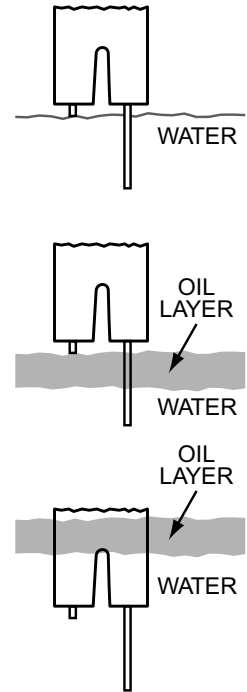

Drawing 1061

Use Copper Conductors Only
 Temperature ratings of conductors is to be 60°C (167°F)
 Branch circuit protection shall be provided by the installer:
 Must be sized according to pump/motor manufacturing specifications.

Wiring Diagram
 Model # OSD3P-10

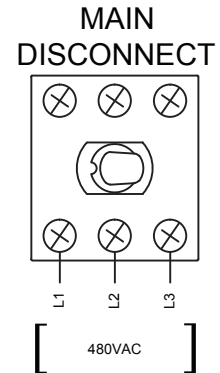
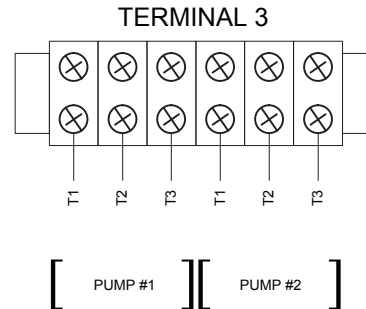
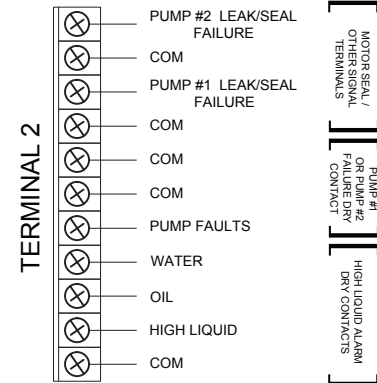
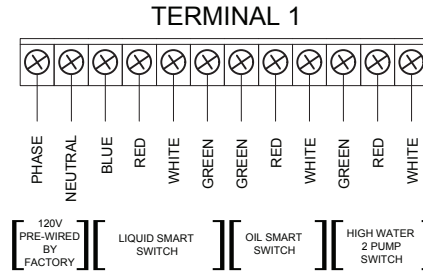
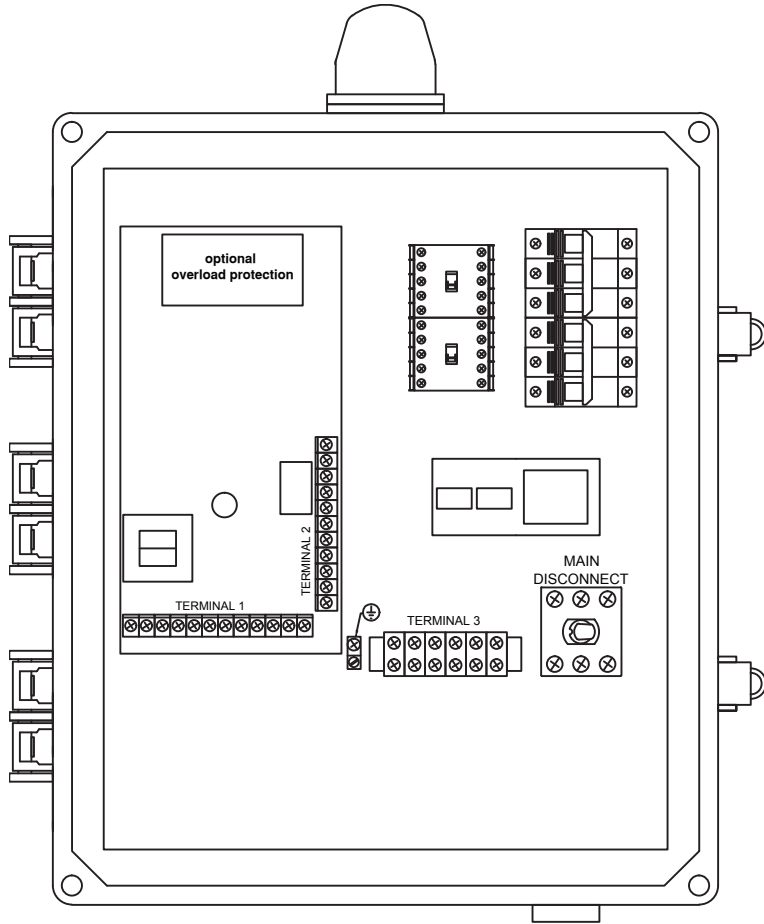

www.seewaterinc.com or www.oilsmart.org
 951.487.8073 • 888.733.9283 • Email: info@seewaterinc.com
 121 North Dillon Street • San Jacinto, CA 92583
 P.O. Box 1269 • San Jacinto, CA 92581



Oil Smart Control Panel Troubleshooting Guide

Problem	Possible Cause	Solution
Pump Control does not activate the pump. Pump does not run.	The Oil Smart Switch will not function with incorrect polarity.	Make sure phase and neutral are not reversed.
	Loose connection in control panel or electrical system.	Confirm all connections are tight and secure.
	Non-Conductive Water (Highly Filtered Water)	Test pump switch with fingers per the instructions (See Page 2)
	Defective Control	Replace Control
Pump Control is not operating properly; not consistent or staying on.	Problem with electrical system	Check electrical circuits for common neutrals; may cause switch to not function correctly.
	Control Panel Wiring Problems	Do not run DC conductors through same conduit as AC conductors. Circulating current can cause problems.
	Control is not clean of conductive material.	White plastic case must be kept clean. Clean with alcohol or an oil base product: kerosene, solvent.
	Control is mounted to metallic pipe	Keep control (1" to 2") clear of any metallic material. Mount to pvc pipe or wrap electrical tape between pipe and switch.
	Float switch attached to pump	Float switch must be removed, secured in manual operation, or replaced with correct pump.
	Defective Control and/or Pump(s)	Replace Control and/or Pump(s)
Alarm will not activate	Power supply failure	Confirm separate 120V power to circuit board. Can be jumpered from incoming power on pump terminal if 120v is available.
	Defective Alarm Sensor	Replace Alarm Sensor
	Loose connection in control panel or electrical system.	Confirm all connections are tight and secure.
Pump will not turn on or pump is not functioning properly.	Incorrect match on control panel and pump.	Confirm correct pump voltage and wires matched to correct control panel
	Loose connection in control panel or electrical system.	Confirm all connections are tight and secure.
	Defective Pump(s)	Replace Pump(s)
Any technical questions on this product should be directed to See Water, Inc at 888-733-9283.		

Warranty:

See Water® Inc. warrants that the See Water Control Panel will be free from defects in material and workmanship for a period beginning as of the date of purchase for (5) years. Replacement of the panel and/or components is only at the sole discretion of See Water Inc. This warranty is valid only when the product is installed in strict compliance with the manufacturer's installation instructions. See Water, Inc. will in no way be responsible for the reliability of any pump that is connected to or operates with See Water, Inc. products. See Water, Inc. will replace the panel when it is returned to See Water's factory, postage prepaid with proof of original purchase included. It is imperative that in no way, can any components/parts be removed from the control panel during installation. Any alterations/additions/changes to the panel will result in a void warranty. Failure to properly install and test this product can result in personal injury or equipment malfunction.